

XS9F111A1L01M8

Inductive proximity sensors XS, inductive sensor XS9 15x32x8, PBT, Sn5mm, 24 VDC, M8 0.15 m



Main

Range of product	Telemecanique Inductive proximity sensors XS
Series name	Application
Sensor type	Inductive proximity sensor
Device application	-
Sensor name	XS9
Sensor design	Flat form 15 x 32 x 8
Size	8 mm
Body type	Fixed
Detector flush mounting acceptance	Flush mountable
Material	Plastic
Enclosure material	PBT
Type of output signal	Analogue
Wiring technique	2-wire
[Sn] nominal sensing distance	5 mm
Output circuit type	DC
Analogue output range	0...10 V
Electrical connection	Remote male connector M8, 3 pins
Cable length	0.15 m
[Us] rated supply voltage	24 V DC
IP degree of protection	IP67 conforming to IEC 60529

Complementary

Detection face	Frontal
Front material	PBT
Operating zone	1...5 mm
Repeat accuracy	<= 3% of Sr
Linearity error	+/- 1 V
Status LED	Without
Supply voltage limits	15...36 V DC
Switching frequency	<= 2000 Hz
Current consumption	0...4 mA no-load
Maximum output current drift	10 %
Marking	CE
Depth	8 mm
Height	32 mm
Width	15 mm

Environment

Product certifications	UL CSA
Ambient air temperature for operation	-25...70 °C
Ambient air temperature for storage	-40...85 °C
Vibration resistance	25 gn amplitude = +/- 2 mm (f = 10...55 Hz) conforming to IEC 60068-2-6
Shock resistance	50 gn for 11 ms conforming to IEC 60068-2-27

Packing Units

Package 1 Weight	0.032 kg
Package 1 Height	0.420 dm
Package 1 width	0.670 dm
Package 1 Length	0.960 dm

Offer Sustainability

REACH Regulation	REACH Declaration
EU RoHS Directive	Pro-active compliance (Product out of EU RoHS legal scope) EU RoHS Declaration
Mercury free	Yes
RoHS exemption information	Yes

Contractual warranty

Warranty	18 months
----------	-----------

Dimensions

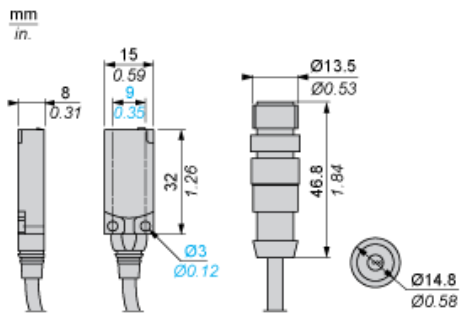

Setting-up

Minimum Mounting Distances (mm)

Side by Side

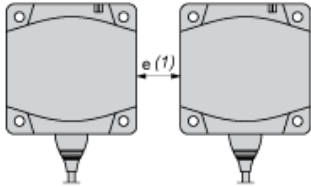

$e (1) \geq 15$

Face to Face

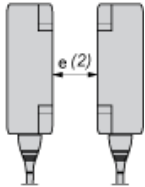

$e (2) \geq 36$

Facing a Metal Object

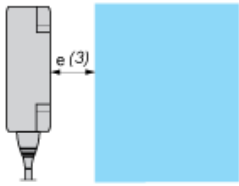

$e (3) \geq 15$

Wiring Schemes

3-Wire Connection

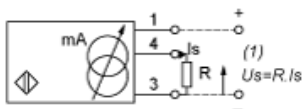

(1) Voltage output

Ensure a minimum of 5 V between the + (terminal 1) and the sensor output (terminal 4)

	Output current	Load impedance value	Output voltage	Load impedance value
24 V	0...10 mA	$R \leq 1400 \Omega$	0...10 V	$R = 1000 \Omega$

M8

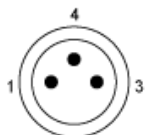

Output Curves

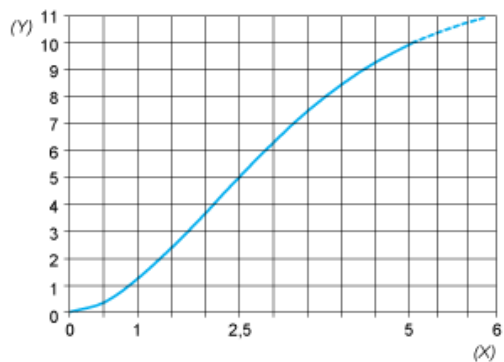

(Y) Us (V)
(X) Sensors - object distance (mm)