

XT130B1PCL2

capacitive sensor - XT1 - cylindrical M30 -
brass - Sn 10 mm - cable 2 m



Main

Range of product	Telemecanique Capacitive proximity sensors XT
Sensor type	Capacitive proximity sensor
Product specific application	Detection of insulated or conductive materials
Sensor name	XT1
Sensor design	Cylindrical M30
Size	70 mm
Body type	Fixed
Detector flush mounting acceptance	Flush mountable
Material	Metal
Enclosure material	Nickel plated brass
Type of output signal	Discrete
Wiring technique	4-wire
[Sn] nominal sensing distance	10 mm
Discrete output function	1 NC + 1 NO
Output circuit type	DC
Discrete output type	PNP
Electrical connection	Cable
Cable length	2 m
[Us] rated supply voltage	24 V DC with reverse polarity protection
Maximum delay response	5 ms
IP degree of protection	IP67 conforming to IEC 60529 IP67 conforming to IEC 60947-5-2

Complementary

ISO thread	M30 x 1.5
Detection face	Frontal
[Sa] assured operating distance	0...7.2 mm
Adjustment zone	2...20 mm
Differential travel	< 0.2 x Sr
Repeat accuracy	< 0.1 x Sr
Wire insulation material	PVC
Status LED	Output state indication: 1 LED (yellow)
Supply voltage limits	12...30 V DC
Maximum residual current	0.1 mA open state
Protection type	Short-circuit protection
Switching frequency	<= 150 Hz
Maximum voltage drop	<2 V (closed)
Current consumption	< 15 mA
Maximum delay first up	30 ms
Maximum delay recovery	5 ms
Maximum switching current	200 mA
Marking	CE
Setting-up	Sensitivity by potentiometer
Threaded length	55 mm

Length	70 mm
Net weight	0.27 kg

Environment

Standards	EN/IEC 60947-5-2
Product certifications	CETLus
Ambient air temperature for operation	-25...70 °C
Vibration resistance	10 gn amplitude = 1 mm (f = 10...55 Hz) conforming to IEC 60068-2-6
Shock resistance	30 gn for 11 ms conforming to IEC 60068-2-27
Resistance to electrostatic discharge	4 kV contact conforming to IEC 61000-4-2 8 kV air conforming to IEC 61000-4-2
Resistance to electromagnetic fields	3 V/m conforming to IEC 61000-4-3
Resistance to fast transients	2 kV conforming to IEC 61000-4-4

Packing Units

Unit Type of Package 1	PCE
Number of Units in Package 1	1
Package 1 Weight	284 g
Package 1 Height	3.5 cm
Package 1 width	16.4 cm
Package 1 Length	15.2 cm
Unit Type of Package 2	S02
Number of Units in Package 2	25
Package 2 Weight	7.356 kg
Package 2 Height	15 cm
Package 2 width	30 cm
Package 2 Length	40 cm

Offer Sustainability

REACH Regulation	REACH Declaration
EU RoHS Directive	Compliant EU RoHS Declaration
Mercury free	Yes
RoHS exemption information	Yes

Contractual warranty

Warranty	18 months
----------	-----------

Dimensions

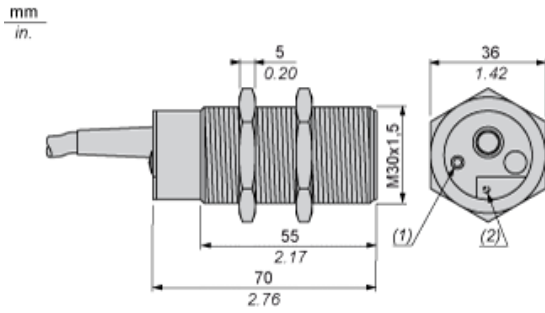

- (1) LED
- (2) Potentiometer beneath protective flap

Setting-up

Minimum Mounting Distances (mm)

Side by side

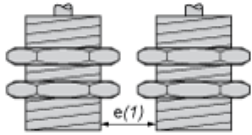

$e(1) \geq 0$

\geq

Face to face

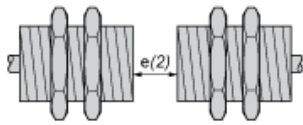

$e(2) \geq 22$

\geq

Facing a metal object

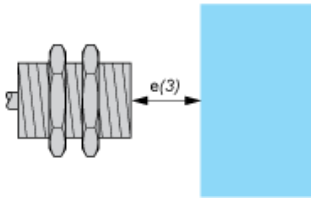

$e(3) \geq 20$

\geq

Mounted in support

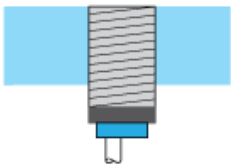

Fixing nut tightening torque: 40 N.m

Adjustment

Sensitivity Adjustment

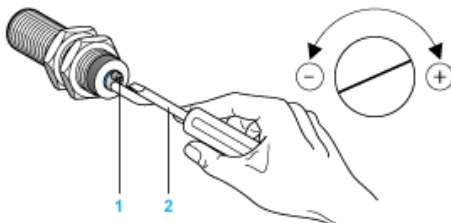

- (1) Adjustment potentiometer
- (2) Screwdriver (included with sensor)

Wiring Diagram

Pre-cabled

4-wire DC, PNP NO + NC Output, Precabled

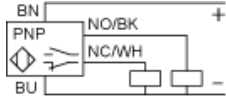

(BU) Blue
(BN) Brown
(BK) Black
(WH) White