

# XMLB004B2C11

Electromechanical pressure sensor, Pressure sensors XM, switch XMLB 4 bar, adjustable scale 2 thresholds, 1 C/O



## Main

Range of product	OsiSense XM
Product or component type	Electromechanical pressure sensor
Pressure sensor type	Electromechanical pressure sensor
Device short name	XMLB
Pressure rating	4 bar
Controlled fluid	Air (0...160 °C) Fresh water (0...160 °C) Hydraulic oil (0...160 °C)
Fluid connection type	G 1/4 (female) conforming to ISO 228
Electrical connection	1 male connector EN 175301-803-A (ex DIN43650), 4 pins
Contacts type and composition	1 C/O
Product specific application	-
Pressure switch type of operation	Regulation between 2 thresholds
Electrical circuit type	Control circuit
Scale type	Adjustable differential
Local display	With
Adjustable range of switching point on rising pressure	0.25...4 bar
Adjustable range of switching point on falling pressure	0.05...3.75 bar
Possible differential maximum at high setting	2.4 bar
Maximum permissible accidental pressure	9 bar
Destruction pressure	18 bar
Pressure actuator	Diaphragm
Materials in contact with fluid	FPM, FKM Steel
Enclosure material	Zinc alloy
[In] rated current	3 A, B300, AC-15 (Ue = 120 V) conforming to EN/IEC 60947-5-1 1.5 A, B300, AC-15 (Ue = 240 V) conforming to EN/IEC 60947-5-1 0.1 A, R300, DC-13 (Ue = 250 V) conforming to EN/IEC 60947-5-1

## Complementary

Possible differential minimum at low setting	0.2 bar (+/- 0.01 bar)
Possible differential minimum at high setting	0.25 bar (- 0.03 bar, + 0.05 bar)
Maximum permissible pressure - per cycle	5 bar
Terminal block type	4 terminals
Maximum operating rate	120 cyc/mn
Repeat accuracy	2 %

The information provided in this documentation contains general descriptions and/or technical characteristics of the performance of the products contained herein. This documentation is not intended as a substitute for and is not to be used for determining suitability or reliability of these products for specific user applications. It is the duty of any such user or integrator to perform the appropriate and complete risk analysis, evaluation and testing of the products with respect to the relevant specific application or use thereof. Neither Schneider Electric Industries SAS nor any of its affiliates or subsidiaries shall be responsible or liable for misuse of the information contained herein.

[Ui] rated insulation voltage	300 V conforming to UL 508 500 V conforming to EN/IEC 60947-1 300 V conforming to CSA C22.2 No 14
[Uimp] rated impulse withstand voltage	EN/IEC 60947-1 6 kV
Auxiliary contacts operation	Snap action
Contacts material	Silver contacts
Maximum resistance across terminals	25 MOhm conforming to IEC 255-7 category 3 25 mOhm conforming to NF C 93-050 method A
Short-circuit protection	10 A cartridge fuse, type gG (gl)
Mechanical durability	8000000 cycles
Setting	External
Height	158 mm
Depth	77.5 mm
Width	35 mm
Net weight	1.03 kg





## Environment

Standards	CE EN/IEC 60947-5-1 CSA C22.2 No 14 UL 508
Product certifications	LROS (Lloyds register of shipping) BV CSA CCC EAC UL
Protective treatment	TC standard version
Ambient air temperature for operation	-25...70 °C
Ambient air temperature for storage	-40...70 °C
Operating position	Any position
Vibration resistance	4 gn conforming to IEC 60068-2-6 (f = 30...500 Hz)
Shock resistance	50 gn conforming to IEC 60068-2-27
Electrical shock protection class	Class I conforming to IEC 1140 Class I conforming to IEC 536 Class I conforming to NF C 20-030
IP degree of protection	IP65 conforming to EN/IEC 60529

## Packing Units

Package 1 Weight	0.001 kg
Package 1 Height	1.450 dm
Package 1 width	0.620 dm
Package 1 Length	0.820 dm

## Offer Sustainability

Sustainable offer status	Green Premium product
REACH Regulation	 <a href="#">REACH Declaration</a>
EU RoHS Directive	Pro-active compliance (Product out of EU RoHS legal scope)  <a href="#">EU RoHS Declaration</a>
Mercury free	Yes
RoHS exemption information	 Yes
Environmental Disclosure	 <a href="#">Product Environmental Profile</a>

## Contractual warranty

Warranty	18 months
----------	-----------

Dimensions

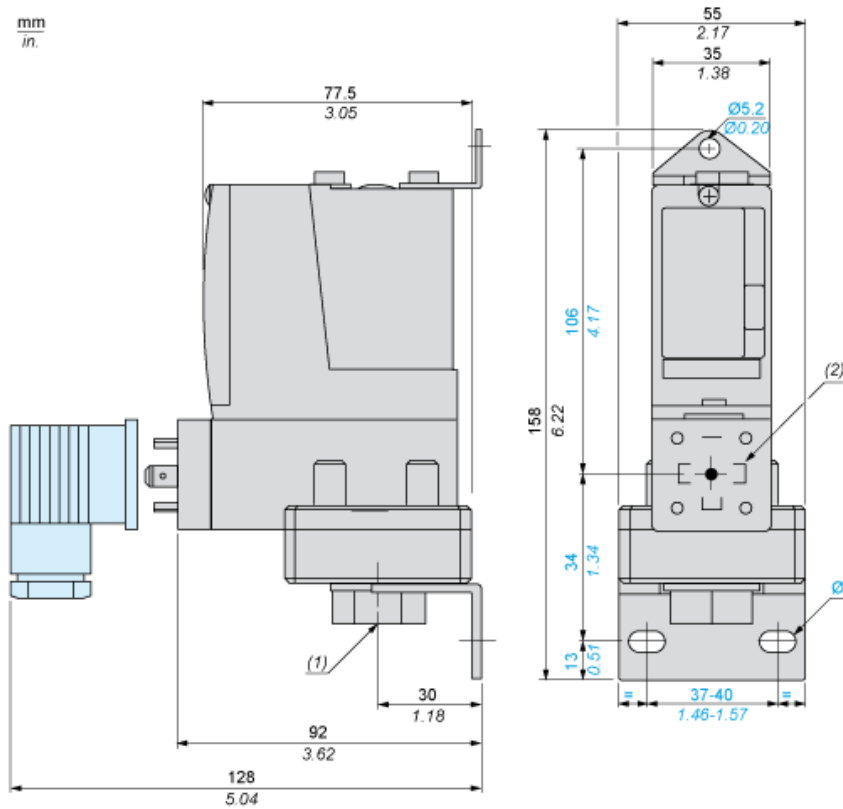

- (1) 1 fluid entry, tapped G1/4 (BSP female)
- (2) EN 175301-803-A connector
- Ø : 2 elongated holes Ø 10.2 x 5.2

---

Wiring Diagram

---

Terminal Model



---

Wiring Diagram

---

Vacuum Switch Connector Pin View

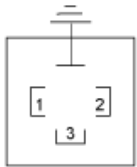

- (1) 11 and 13
- (2) 12
- (3) 14

Operating Curves

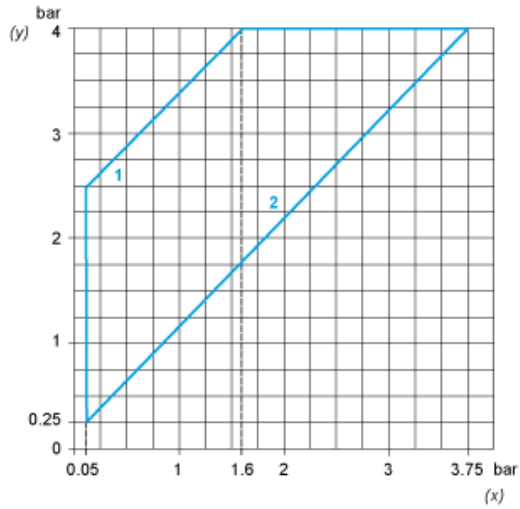

- (y) Rising pressure
- (x) Falling pressure
- 1 : Maximum differential
- 2 : Minimum differential



- (y) Pressure
- (x) Time
- (1) Adjustable value
- PH : High point
- PB : Below point