

XUYPS2945S

Photoelectric sensors XU, photo electric sensor, XUY, BGS, 2 channels, Sn 600 mm, 12...24 VDC, cable 2 m



Main

Range of product	Telemecanique Photoelectric sensors XU
Series name	Application material handling
Electronic sensor type	Photo-electric sensor
Sensor name	XUY
Sensor design	Compact
Detection system	Diffuse with background suppression
Material	Plastic
Type of output signal	Discrete
Supply circuit type	DC
Wiring technique	4-wire
Discrete output type	PNP and NPN
Discrete output function	1 NO or 1 NC programmable
Electrical connection	Cable
Cable length	2 m
Product specific application	2 channels triangulation Control of filling Detection of object on conveyor against reflective background
Emission	Infrared LED, modulated
[Sn] nominal sensing distance	50...600 mm

Complementary

Enclosure material	Glass impregnated nylon
Output type	Solid state
Status LED	Output state: 1 LED (green)
[Us] rated supply voltage	12...24 V DC with reverse polarity protection
Supply voltage limits	10...30 V DC
Switching capacity in mA	100 mA (overload and short-circuit protection)
Switching frequency	> 370 Hz
Maximum voltage drop	<2 V (closed state)
Current consumption	< 1.5 mA no-load
Maximum delay response	1.8 ms
Maximum delay recovery	1.8 ms
Net weight	0.135 kg

Environment

Product certifications	CE
Ambient air temperature for operation	0...50 °C
Ambient air temperature for storage	-20...60 °C
Immunity to ambient light	10000 Lux natural light 1300 lux incandescent bulb
IP degree of protection	IP65 conforming to IEC 60529

The information provided in this documentation contains general descriptions and/or technical characteristics of the performance of the products contained herein. This documentation is not intended as a substitute for and is not to be used for determining suitability or reliability of these products for specific user applications. It is the duty of any such user or integrator to perform the appropriate and complete risk analysis, evaluation and testing of the products with respect to the relevant specific application or use thereof. Neither Schneider Electric Industries SAS nor any of its affiliates or subsidiaries shall be responsible or liable for misuse of the information contained herein.

Packing Units

Package 1 Weight	0.172 kg
Package 1 Height	1.600 dm
Package 1 width	0.450 dm
Package 1 Length	1.100 dm

Offer Sustainability

REACH Regulation	REACH Declaration
EU RoHS Directive	Pro-active compliance (Product out of EU RoHS legal scope) EU RoHS Declaration
Mercury free	Yes
RoHS exemption information	Yes

Contractual warranty

Warranty	18 months
----------	-----------

Dimensions

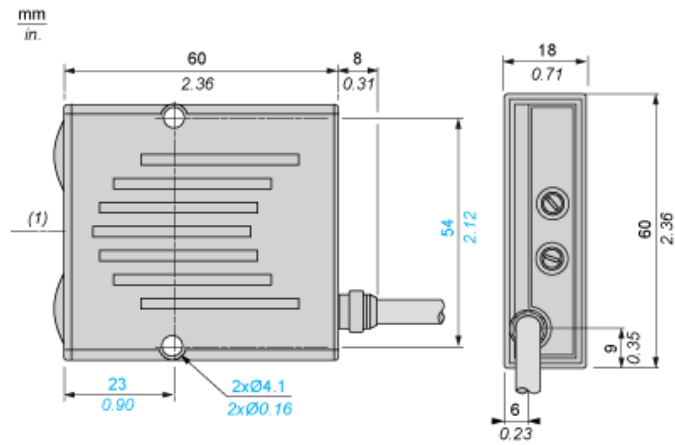

Mounting and Clearance

Two independent sensors with triangulation: A, B

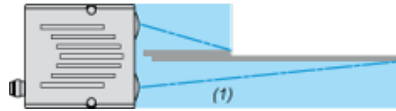

(1) Detected zones

Immunity to reflection: A and B

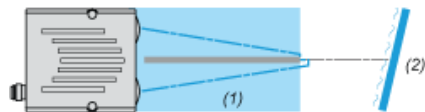

(1) Detected zones
(2) Mirror

Detection of contrasting objects: A or B

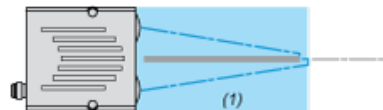

(1) Detected zones

Monitoring of distance: A xor B

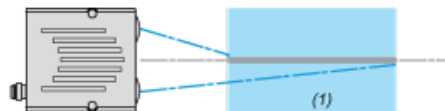

(1) Detected zones

Wiring Schemes and Outputs

Two Independent Sensors with Triangulation: A, B

NO Output

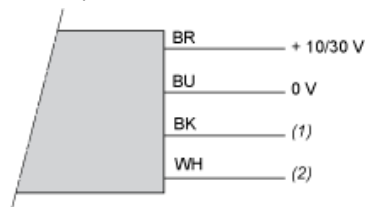

NC Output

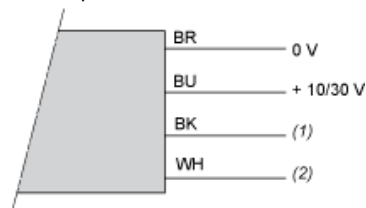

BN : Brown

BU : Blue

BK : Black

WH : White

(1) Zone A output

(2) Zone B output

Immunity to Reflection: A and B

Without Time Delay

NO Output

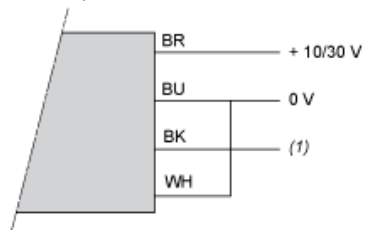

NC Output

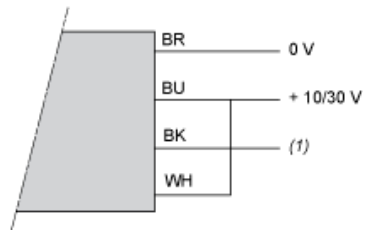

BN : Brown

BU : Blue

BK : Black

WH : White

(1) Output

With 40 ms Time Delay

NO Output

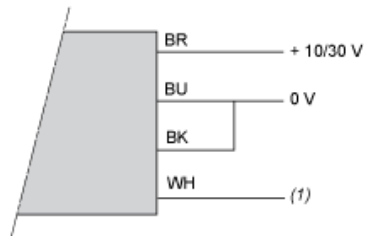

NC Output

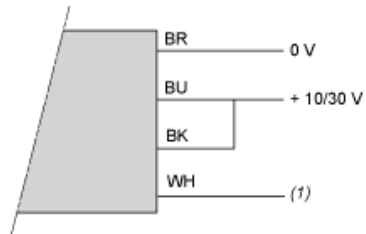

BN : Brown
BU : Blue
BK : Black
WH : White
(1) Output

Detection of Contrasting Objects: A or B

NO Output

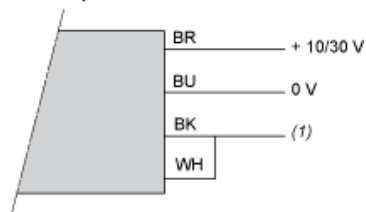

NC Output

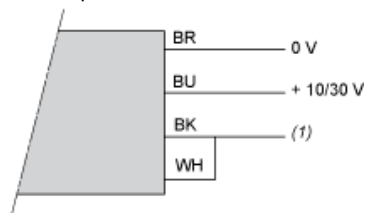

BN : Brown
BU : Blue
BK : Black
WH : White
(1) Output

Monitoring of Distance: A or B

Without Time Delay

NO Output

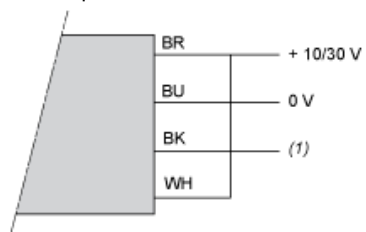

NC Output

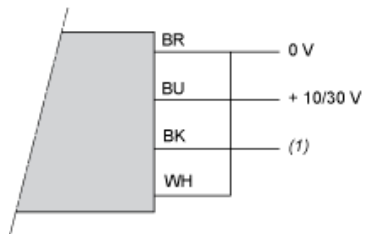

BN : Brown
BU : Blue
BK : Black
WH : White
(1) Output

With 40 ms Time Delay

NO Output

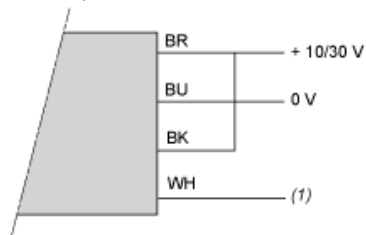

NC Output

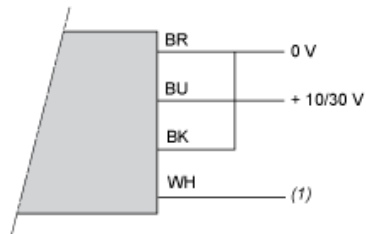

BN : Brown
BU : Blue
BK : Black
WH : White
(1) Output

Detection Curves

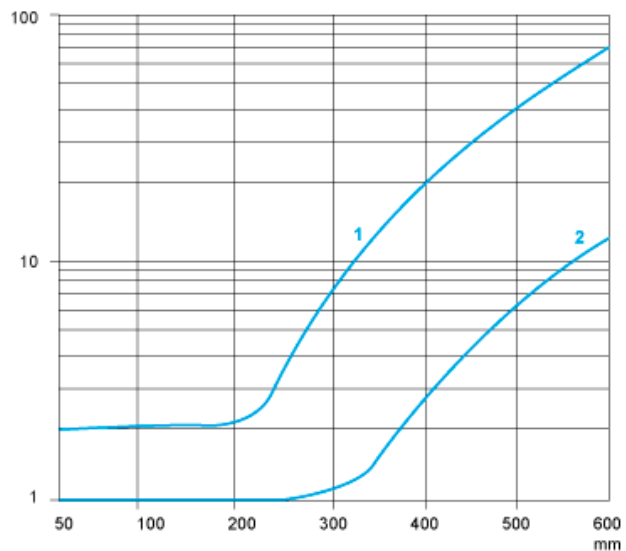

- 1 : Black 6%
- 2 : Grey 18% - Distance (mm) set on 92% (Kodak 1527795)