

XUM0ANSAM8

Photoelectric sensors XU, photo electric sensor, XUM, multi, Sn 0...10 m, 12...24 VDC, M8



Main

Range of product	Telemecanique Photoelectric sensors XU
Series name	General purpose multimode
Electronic sensor type	Photo-electric sensor
Sensor name	XUM
Sensor design	Miniature
Detection system	Multimode
Material	Plastic
Type of output signal	Discrete
Supply circuit type	DC
Wiring technique	3-wire
Discrete output type	NPN
Discrete output function	1 NO or 1 NC programmable
Electrical connection	1 male connector M8, 4 pins
Product specific application	-
Emission	Infrared diffuse Infrared diffuse with background suppression Infrared thru beam Red polarised reflex
[Sn] nominal sensing distance	3 M polarised reflex need reflector XUZC50 10 M thru beam need a transmitter XUM0AKSAM8T 0.1 M diffuse with background suppression 0.4 m diffuse

Complementary

Enclosure material	PBT
Lens material	PMMA
Maximum sensing distance	14 M thru beam 4 M polarised reflex 0.1 M diffuse with background suppression 0.55 m diffuse
Output type	Solid state
Add on output	With alarm output, 50 mA
Wire insulation material	PVC
Status LED	1 LED (green) for supply 1 LED (red) for instability 1 LED (yellow) for output state
[Us] rated supply voltage	12...24 V DC with reverse polarity protection
Switching capacity in mA	<= 100 mA (overload and short-circuit protection)
Switching frequency	<= 250 Hz 240 Hz
Maximum voltage drop	<1.5 V (closed state)
Current consumption	35 mA no-load
Maximum delay first up	100 ms
Maximum delay response	2 ms
Maximum delay recovery	2 ms
Setting-up	Self-teaching
Depth	20 mm
Height	45 mm

Width	12 mm
Net weight	0.035 kg

Environment

Product certifications	UL CE CSA
Ambient air temperature for operation	-25...55 °C
Ambient air temperature for storage	-40...70 °C
Vibration resistance	7 gn, amplitude = +/- 1.5 mm (f = 10...55 Hz) conforming to IEC 60068-2-6
Shock resistance	30 gn (duration = 11 ms) conforming to IEC 60068-2-27
IP degree of protection	IP65 conforming to IEC 60529 IP67 conforming to IEC 60529

Packing Units

Package 1 Weight	0.039 kg
Package 1 Height	0.420 dm
Package 1 width	0.960 dm
Package 1 Length	0.670 dm

Offer Sustainability

Sustainable offer status	Green Premium product
REACH Regulation	REACH Declaration
EU RoHS Directive	Pro-active compliance (Product out of EU RoHS legal scope) EU RoHS Declaration
Mercury free	Yes
RoHS exemption information	Yes
Environmental Disclosure	Product Environmental Profile
Circularity Profile	End Of Life Information

Contractual warranty

Warranty	18 months
----------	-----------

Dimensions

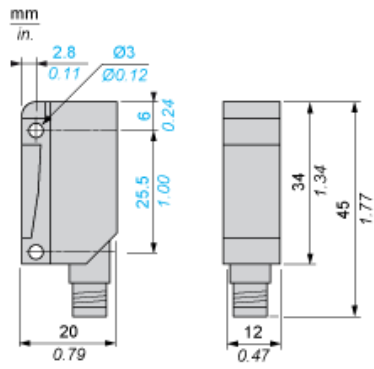

Mounting and Clearance

Possible Orientation of Elbowed Connector

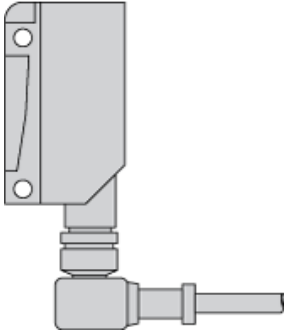

Wiring Schemes

M8 Connector

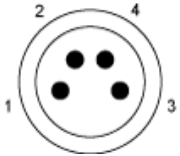

- 1 : (+)
- 3 : (-)
- 4 : OUT/Output

Receiver, NPN Output

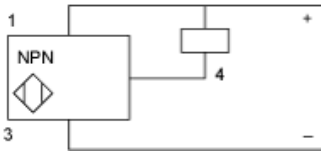

Detection Curves

With Thru-beam Accessory (Thru-beam)

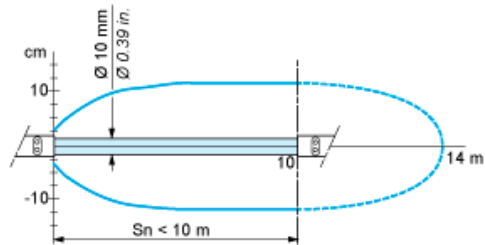

Without Accessory (Diffuse)

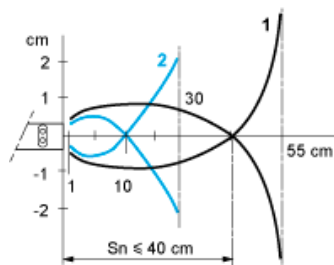

1: White 90%
2: Grey 18%
Object 10 x 10 cm

Without Accessory (Diffuse with background suppression)

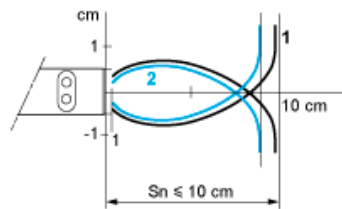

1: White 90%
2: Grey 18%
Object 10 x 10 cm

With reflector (Polarised reflex)

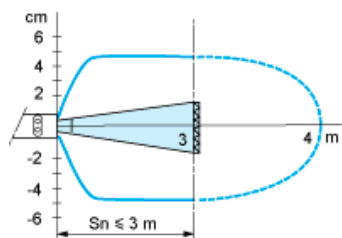

With reflector XUZC50

Variation of Usable Sensing Distance S_u (Without accessory, with adjustable background suppression)

Teach Mode at Minimum

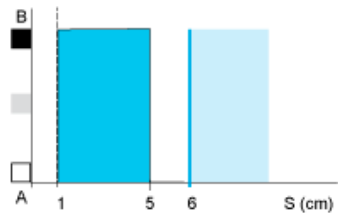

Teach Mode at Maximum

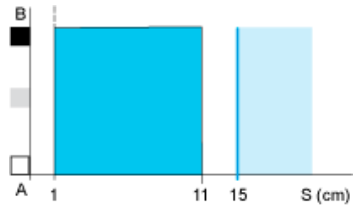

- (1) Black 6%
- (2) Grey 18%
- (3) White 90%
- (4) Sensing range
- (5) Non sensing zone (matt surfaces)

A-B : Object reflection coefficient

- (1) Black 6%
- (2) Grey 18%
- (3) White 90%
- (4) Sensing range
- (5) Non sensing zone (matt surfaces)