



## Main

Range of product	Telemecanique Photoelectric sensors XU
Series name	Application material handling Application assembly
Electronic sensor type	Photo-electric sensor
Sensor name	XUK
Sensor design	Compact 50 x 50
Detection system	Diffuse with background suppression
Material	Plastic
Type of output signal	Discrete
Wiring technique	4-wire
Discrete output type	PNP or NPN
Discrete output function	1 NO or 1 NC programmable
Electrical connection	1 male connector M12, 4 pins
Product specific application	Suppression of a background Distance measurement on object
Emission	Red laser diffuse with background suppression class 1 conforming to IEC 60825-1
[Sn] nominal sensing distance	5 m diffuse with background suppression

## Complementary

Enclosure material	ABS/PC
Lens material	PMMA
Maximum sensing distance	5 m diffuse with background suppression
Output type	Solid state
Add on input	External teach
Wire insulation material	PVC
Status LED	1 LED (yellow) for output state 1 LED (green/yellow) for supply on/output state
[Us] rated supply voltage	12...24 V DC with reverse polarity protection
Supply voltage limits	10...30 V DC
Switching capacity in mA	<= 100 mA (overload and short-circuit protection)
Switching frequency	<= 250 Hz
Maximum voltage drop	<1.5 V (closed state)
Current consumption	<= 60 mA no-load
Maximum delay first up	300 ms
Maximum delay response	2 ms
Maximum delay recovery	2 ms
Setting-up	Using teach button or remote teaching
Depth	50 mm
Height	50 mm
Width	23 mm
Net weight	0.035 kg



## Environment

Product certifications	Ecolab CE CULus
Ambient air temperature for operation	-20...50 °C, UL certified -40...60 °C
Ambient air temperature for storage	-40...80 °C
Vibration resistance	7 gn, amplitude = +/- 1.5 mm (f = 10...55 Hz) conforming to IEC 60068-2-6
Shock resistance	30 gn (duration = 11 ms) conforming to IEC 60068-2-27
IP degree of protection	IP67 conforming to IEC 60529 IP69K conforming to DIN 40050

## Packing Units

Unit Type of Package 1	PCE
Number of Units in Package 1	1
Package 1 Weight	56 g
Package 1 Height	2.8 cm
Package 1 width	9 cm
Package 1 Length	6 cm
Unit Type of Package 2	S01
Number of Units in Package 2	28
Package 2 Weight	1.681 kg
Package 2 Height	15 cm
Package 2 width	15 cm
Package 2 Length	40 cm

## Offer Sustainability

REACH Regulation	 <a href="#">REACH Declaration</a>
EU RoHS Directive	Pro-active compliance (Product out of EU RoHS legal scope)  <a href="#">EU RoHS Declaration</a>
Mercury free	Yes
RoHS exemption information	 <a href="#">Yes</a>

## Contractual warranty

Warranty	18 months
----------	-----------

## Dimensions

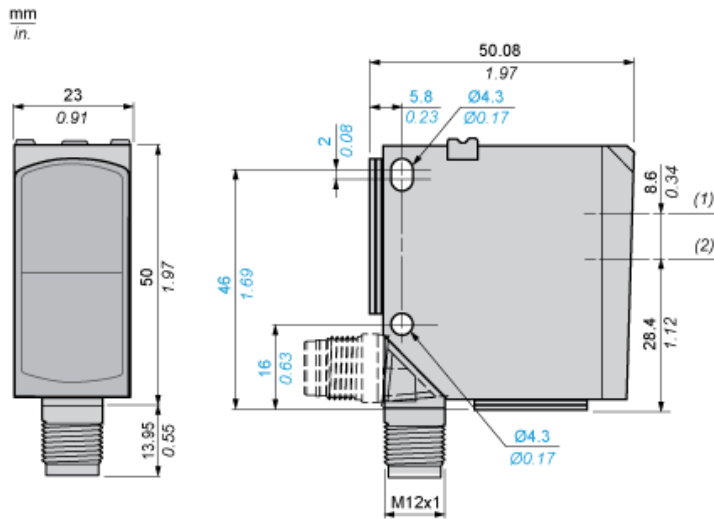

- (1) Transmitter optical axis
- (2) Receiver optical axis

## Connections and Schema

### Connector Wiring

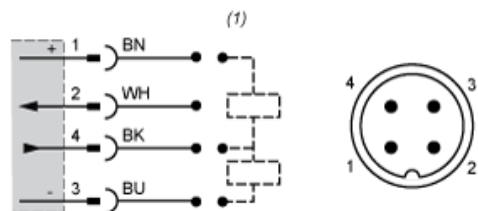

- (1) Auto-detect  
1: + UB (BN: Brown)  
2: IN (WH: White)  
3: -UB (BU: Blue)  
4: OUT (BK: Black)

Curves

Size of light spot (typical)

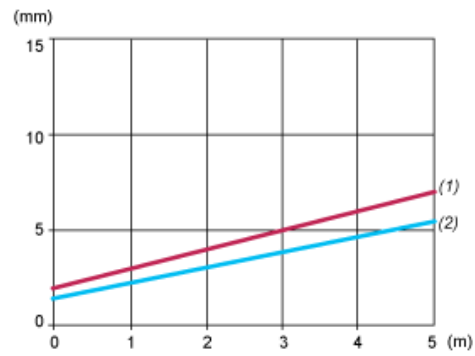

(1) Vertical (y)  
(2) Horizontal (x)  
0... Size  
15  
mm :  
0...5 Distance  
m :

---

Mounting

---

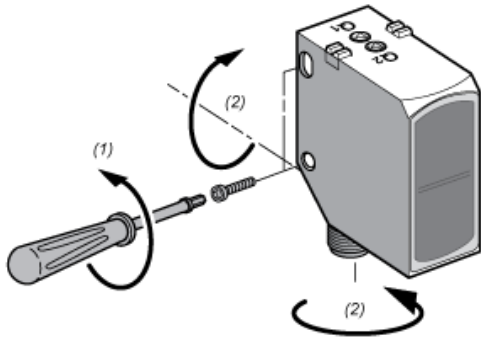

- (1) < 1,5 Nm (13 lb-in)
- (2) < 1 Nm (8.85 lb-in)