



Main

Range of product	Telemecanique Cabling components
Accessory / separate part category	Cabling accessory
Accessory / separate part type	Pre-wired connectors
Series name	General purpose

Complementary

Electrical connection	Elbowed female connector Ø 8 mm, 3 pins
Cable connector fixing	Clip-on
Status LED	Without
Cable length	2 m
Cable outer diameter	5.2 mm
Cable composition	3 x 0.34 mm ²
Wire insulation material	PUR
[Ue] rated operational voltage	60 V AC 75 V DC
[In] rated current	4 A
Contact resistance	5000 µOhm
Minimum insulating resistance	1 GΩ
Net weight	0.05 kg

Environment

IP degree of protection	IP65 IP67
Product certifications	CULus
Ambient air temperature for operation	-40...80 °C static -5...80 °C flexing
Ambient air temperature for storage	-40...80 °C

Packing Units

Unit Type of Package 1	PCE
Number of Units in Package 1	1
Package 1 Weight	56 g
Package 1 Height	1 cm
Package 1 width	14 cm
Package 1 Length	14 cm
Unit Type of Package 2	S02
Number of Units in Package 2	40
Package 2 Weight	2.566 kg
Package 2 Height	15 cm

Package 2 width	30 cm
Package 2 Length	40 cm

Offer Sustainability

Sustainable offer status	Green Premium product
REACH Regulation	REACH Declaration
EU RoHS Directive	Pro-active compliance (Product out of EU RoHS legal scope) EU RoHS Declaration
Mercury free	Yes
RoHS exemption information	Yes
Environmental Disclosure	Product Environmental Profile
Circularity Profile	End Of Life Information

Contractual warranty

Warranty	18 months
----------	-----------

Dimensions

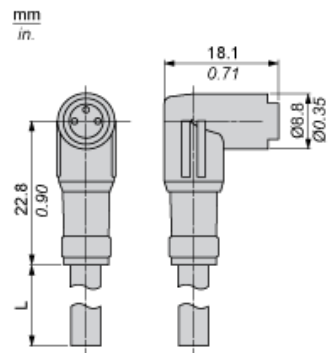

L : Length of cable

Connections and Schemes

Connector

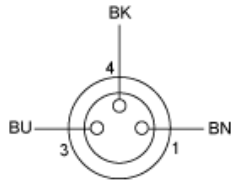

BU : Blue
BN : Brown
BK : Black