



Main

| | |
|---|--|
| Range of product | Interface for discrete signals |
| Product or component type | Slim electromechanical output interface module |
| Contacts type and composition | 1 NO |
| [Uc] control circuit voltage | 24 V |
| Control circuit type | DC |
| Width pitch dimension | 12 mm |
| Maximum [In] rated current | 28 mA |
| Reverse polarity protection | With |
| Short-circuit protection | 6.3 A external fuse fast blow (Ik <= 1 kA AC and Ik <= 100 A DC) |
| [Ith] conventional free air thermal current | 5 A conforming to IEC 60947-1 |
| Local signalling | Green LED for control signal state |
| Sale per indivisible quantity | 5 |

Complementary

| | |
|--------------------------------|--|
| Control circuit voltage limits | 28.8 V energization threshold: 16.9 V |
| Connections - terminals | Screw clamp terminal |
| Drop-out voltage | 3.8 V |
| Holding current | 2 mA |
| Power dissipation in W | 0.64 W |
| Maximum switching voltage | 150 V DC 250 V AC |
| [Ue] rated operational voltage | <= 120 V DC conforming to IEC 60947-5-1 <= 230 V AC conforming to IEC 60947-5-1 |
| Network frequency | 50/60 Hz |
| [Ie] rated operational current | 1 A AC-14 Ue: 230 V per 1000000 cycles conforming to IEC 60947-5-1 1 A AC-15 Ue: 230 V per 1000000 cycles conforming to IEC 60947-5-1 3 A AC-12 Ue: 230 V per 1000000 cycles conforming to IEC 60947-5-1 1.5 A DC-13 Ue: 24 V per 1000000 cycles conforming to IEC 60947-5-1 1.7 A DC-12 Ue: 24 V per 1000000 cycles conforming to IEC 60947-5-1 |
| Minimum switching current | 5 mA |
| Minimum switching voltage | 5 V |
| Electrical reliability | <= 0.00000001 |
| Operating time | <= 10 ms between energisation of coil and closing of NO contact DC <= 12 ms between de-energisation of coil and closing of NO contact DC |
| Contact bounce time | <= 5 ms |
| Operating rate in Hz | 10 Hz at no-load 0.5 Hz at Ie |
| Mechanical durability | 10000000 cycles |
| [Ui] rated insulation voltage | 250 V conforming to VDE 0110 group C 300 V conforming to IEC 60947-1 |
| Flame retardance | V0 conforming to UL 94 |
| Cable cross section | 0.34...2.5 Mm ² , 1 or 2 wires flexible with cable end 0.6...2.5 Mm ² , 1 or 2 wires flexible without cable end 0.27...4 mm ² , 1 wire rigid |

| | |
|-----------------------|---|
| Operating position | Any position |
| Installation category | II conforming to IEC 60947-1 |
| Mounting support | Symmetrical DIN rail Combination rail Asymmetrical DIN rail |
| Net weight | 0.041 kg |

Environment

| | |
|---------------------------------------|---|
| Immunity to microbreaks | 1 ms |
| Dielectric strength | 1000 V for 1 minute between open contacts 2500 V for 1 minute between wired interface and earth 4000 V for 1 minute between coil circuit and contact circuits |
| Standards | IEC 60947-5-1 |
| Product certifications | CSA LROS (Lloyds register of shipping) BV DNV UL |
| IP degree of protection | IP20 conforming to IEC 60529 |
| Protective treatment | TC |
| Fire resistance | 960 °C conforming to IEC 60695-2-1 |
| Shock resistance | 30 gn for 11 ms conforming to IEC 60068-2-27 |
| Vibration resistance | 3 gn conforming to IEC 60068-2-6 (f = 10...150 Hz) |
| Electromagnetic compatibility | Electromagnetic field immunity test: level 3 10 V/m between 27...1000 MHz conforming to IEC 61000-4-3 Electrostatic discharge immunity test: level 3 8 kV conforming to IEC 61000-4-2 Fast transients immunity test: level 3 on input/output 1 kV conforming to IEC 61000-4-4 Fast transients immunity test: level 3 on power supply 2 kV conforming to IEC 61000-4-4 1.2/50 µs shock waves immunity test conforming to IEC 60947-1 |
| Ambient air temperature for operation | -25...55 °C at Us -25...70 °C at Us with 8 mm space between ABR2S1... -5...40 °C unrestricted operation -5...55 °C from 0.85...1.1 Us |
| Ambient air temperature for storage | -40...80 °C |
| Operating altitude | <= 3000 m |
| Pollution degree | 2 conforming to IEC 60947-1 |

Packing Units

| | |
|------------------------------|----------|
| Unit Type of Package 1 | PCE |
| Number of Units in Package 1 | 1 |
| Package 1 Weight | 48 g |
| Package 1 Height | 7.3 cm |
| Package 1 width | 9 cm |
| Package 1 Length | 10.7 cm |
| Unit Type of Package 2 | BB1 |
| Number of Units in Package 2 | 5 |
| Package 2 Weight | 240 g |
| Package 2 Height | 7.3 cm |
| Package 2 width | 9 cm |
| Package 2 Length | 10.7 cm |
| Unit Type of Package 3 | S02 |
| Number of Units in Package 3 | 75 |
| Package 3 Weight | 4.055 kg |
| Package 3 Height | 15 cm |
| Package 3 width | 30 cm |
| Package 3 Length | 40 cm |

Offer Sustainability

| | |
|----------------------------|---|
| Sustainable offer status | Green Premium product |
| REACH Regulation | REACH Declaration |
| EU RoHS Directive | Pro-active compliance (Product out of EU RoHS legal scope) EU RoHS Declaration |
| Mercury free | Yes |
| RoHS exemption information | Yes |
| China RoHS Regulation | China RoHS Declaration |
| Environmental Disclosure | Product Environmental Profile |
| WEEE | The product must be disposed on European Union markets following specific waste collection and never end up in rubbish bins |

Contractual warranty

| | |
|----------|-----------|
| Warranty | 18 months |
|----------|-----------|

Slim Electromechanical Interface Module

Dimensions

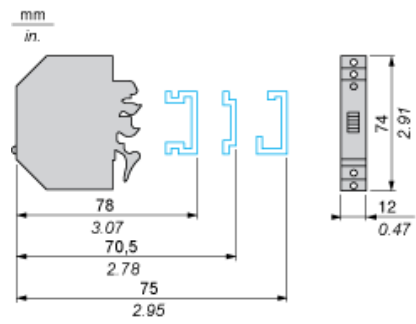

Slim Electromechanical Interface Module

Example of Application with PLC

Interfacing PLC discrete outputs

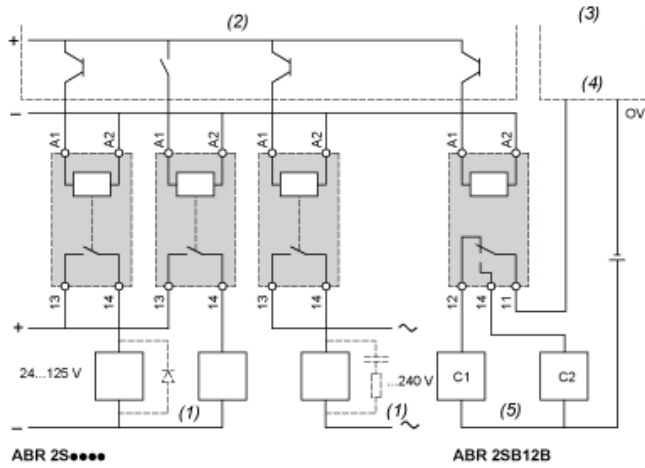

- (1) Essential on inductive loads (can be replaced with peak limiter)
- (2) PLC positive logic transistor (or relay) outputs
- (3) PLC analog inputs
- (4) Channel X
- (5) Analog sensors

Slim Electromechanical Interface Module

Circuit Diagram

1 N/O

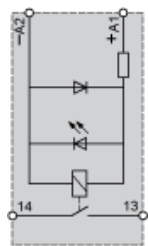

Electrical Durability of Contacts

AC Loads

Test conditions: in accordance with standard IEC 947-5-1 set up for rated control voltage.

AC-12 operating cycles in millions

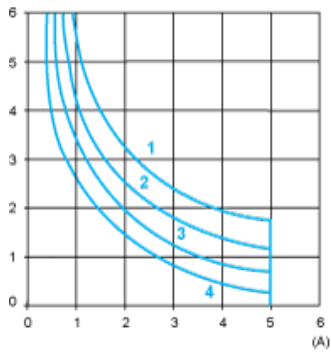

AC-12 Control of resistive loads and isolated solid state loads via optocoupler ($\cos \phi \geq 0.9$)

- (1) 24 V
- (2) 48 V
- (3) 115 V
- (4) 230 V

AC-14 and AC-15 operating cycles in millions

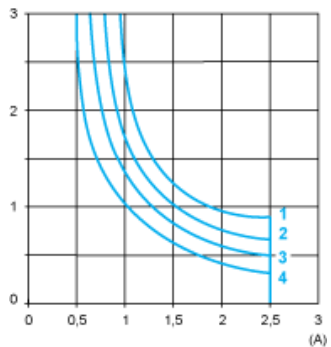

AC-14 Control of weak electro-magnetic loads of electro-magnets ≤ 72 VA (make: $\cos \phi = 0.3$, break: $\cos \phi = 0.3$)

AC-15 Control of electro-magnetic loads of electro-magnets > 72 VA (make: $\cos \phi = 0.7$, break: $\cos \phi = 0.4$)

- (1) 24 V
- (2) 48 V
- (3) 115 V
- (4) 230 V

DC Loads

Test conditions: in accordance with standard IEC 947-5-1 set up for rated control voltage.

DC-12 operating cycles in millions

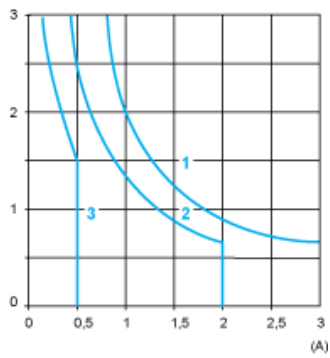

DC-12 Control of resistive loads and isolated solid state loads via optocoupler ($L/R \leq 1$ ms)

- (1) 24 V
- (2) 48 V
- (3) 115 V

DC-13 operating cycles in millions

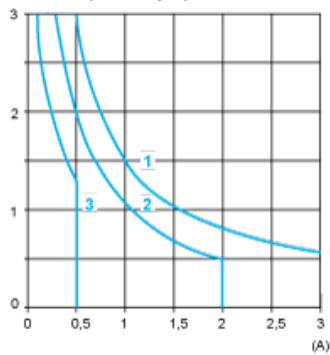

DC-13 Control of electro-magnets ($L/R \leq 2 \times (U_e \times I_e)$ in ms, with U_e : rated operating voltage and I_e : rated operating current, with a load protection diode

- (1) 24 V
- (2) 48 V
- (3) 115 V