

KTA0800ER44

Flat elbow feed unit, Canalis KTA, aluminium, 800A, 3L+N+PE, made to measure dimensions, neutral N4, white RAL9001

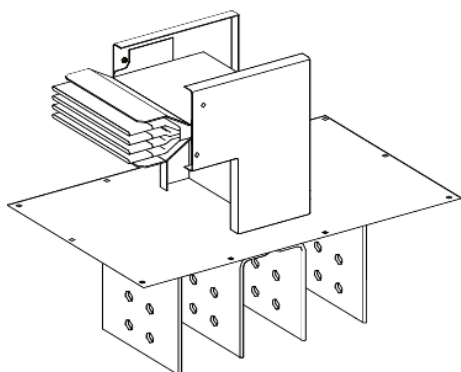

Main

Range	Canalis
Product name	KT
Product or component type	Flatwise elbow feeder trunking
Device short name	KTA
Device application	Feeder length
Supply	Switchboard Oil-immersed transformer
Material	Aluminium
[Ie] rated operational current	800 A at 35 °C
Neutral position	Up
Direction change type	Direction 1: edgewise to left
Earth conductor	Standard earth
Short-circuit level	Standard version
Provided equipment	Trunking unit

Complementary

Housing material	Polyester film
Contacts material	Copper
[Ue] rated operational voltage	1000 V
Network frequency	50/60 Hz
[Ui] rated insulation voltage	1000 V
[Icw] rated short-time withstand current	31 kA
[Ipk] rated peak withstand current	64 kA
Radiated magnetic field	0.4 µT
Thermal stress limit	961000 kA ² .s
THDI	0...15 % 800 A 15...33 % 1000 A 33...100 % 1250 A
Maximum voltage drop	<0.0083 V with power factor = 1 at 50 Hz with 1A for 100 m long <0.0081 V with power factor = 0.9 at 50 Hz with 1A for 100 m long <0.0076 V with power factor = 0.8 at 50 Hz with 1A for 100 m long <0.0069 V with power factor = 0.7 at 50 Hz with 1A for 100 m long
Mounting mode	By screws
Mounting support	Plate
Polarity	3L + N + PE
Number of tap-off outlets	0
Standards	IEC 61439-1 IEC 61439-6
Dimension type	Made to measure
Connection pitch	80...250 mm
Depth	230 mm
Height	Direction 1: 200...534 mm
Length	Direction 2: 300 mm
Colour	White (RAL 9001)
Linear load	13 kg/m

Environment

IP degree of protection	IP55 conforming to IEC 60529
IK degree of protection	IK08 conforming to IEC 62262
Derating factor	0...35 °C (100 % of In) 35...40 °C (97 % of In) 40...45 °C (93 % of In) 45...50 °C (90 % of In) 50...55 °C (86 % of In)

Packing Units

Unit Type of Package 1	PCE
Number of Units in Package 1	1
Package 1 Height	80.0 cm
Package 1 Width	95.0 cm
Package 1 Length	23.0 cm
Package 1 Weight	26.4 kg

Offer Sustainability

Sustainable offer status	Green Premium product
REACH Regulation	REACH Declaration
REACH free of SVHC	Yes
EU RoHS Directive	Compliant EU RoHS Declaration
Toxic heavy metal free	Yes
Mercury free	Yes
China RoHS Regulation	China RoHS Declaration
RoHS exemption information	Yes
Environmental Disclosure	Product Environmental Profile
Circularity Profile	End Of Life Information
WEEE	The product must be disposed on European Union markets following specific waste collection and never end up in rubbish bins
PVC free	Yes
Halogen content performance	Halogen free product