

K1F003UCH

Cam changeover switch, Harmony K, Ø 22mm, plastic, 3 poles, position 0, 45°, 12A, 45x45mm, metallic legend, marked 2/0/1, 35mm black handle



Main

Range of product	Harmony K
Product or component type	Complete cam switch
Component name	K1
[Ith] conventional free air thermal current	12 A
Product mounting	Front mounting
Fixing mode	Ø 22 mm hole
Cam switch head type	With front plate 45 x 45 mm
Type of operator	Black handle, length = 35 mm
Rotary handle padlocking	Without
Presentation of legend	With metallic legend, 2 - 0 - 1 black marking
Cam switch function	Changeover switch
Return	Without
Off position	With Off position
Poles description	3P
Switching positions	Left: 0° - 315° Right: 0° - 45°
IP degree of protection	IP65 conforming to IEC 60529

Complementary

Switching angle	45 °
[Ui] rated insulation voltage	690 V (pollution degree 3) conforming to IEC 60947-1
[Ithe] conventional enclosed thermal current	10 A
Rated operational power in W	10500 W AC-21, 500...660 V 3 phases conforming to IEC 947-3 1100 W AC-3, 230 V 3 phases conforming to IEC 947-3 1500 W AC-23A, 230 V 3 phases conforming to IEC 947-3 1500 W AC-3, 400 V 1 phase conforming to IEC 947-3 1500 W AC-3, 400 V 3 phases conforming to IEC 947-3 1500 W AC-3, 500 V 3 phases conforming to IEC 947-3 1500 W AC-3, 690 V 3 phases conforming to IEC 947-3 2200 W AC-23A, 400 V 3 phases conforming to IEC 947-3 2200 W AC-23A, 500 V 3 phases conforming to IEC 947-3 2200 W AC-23A, 690 V 3 phases conforming to IEC 947-3 4800 W AC-21, 230 V 3 phases conforming to IEC 947-3 600 W AC-3, 230 V 1 phase conforming to IEC 947-3 8300 W AC-21, 400 V 3 phases conforming to IEC 947-3
[Ie] rated operational current AC	1.8 A at 690 V AC-3 3 phases conforming to IEC 947-3 2.8 A at 500 V AC-3 3 phases conforming to IEC 947-3 2.8 A at 690 V AC-23A 3 phases conforming to IEC 947-3 3.3 A at 400 V AC-3 3 phases conforming to IEC 947-3 3.8 A at 500 V AC-23A 3 phases conforming to IEC 947-3 4.6 A at 230 V AC-3 3 phases conforming to IEC 947-3 4.8 A at 400 V AC-23A 3 phases conforming to IEC 947-3 5.6 A at 230 V AC-23A 3 phases conforming to IEC 947-3 1 A at 500 V AC-15 conforming to IEC 947-5-1 2 A at 400 V AC-15 conforming to IEC 947-5-1 3 A at 230 V AC-15 conforming to IEC 947-5-1

The information provided in this documentation contains general descriptions and/or technical characteristics of the performance of the products contained herein. This documentation is not intended as a substitute for and is not to be used for determining suitability or reliability of these products for specific user applications. It is the duty of any such user or integrator to perform the appropriate and complete risk analysis, evaluation and testing of the products with respect to the relevant specific application or use thereof. Neither Schneider Electric Industries SAS nor any of its affiliates or subsidiaries shall be responsible or liable for misuse of the information contained herein.

Electrical durability	1000000 Cycles AC-15 1000000 Cycles AC-21 500000 Cycles AC-23 500000 cycles AC-3
Maximum operating rate	2.5 Cyc/Mn AC-21 2.5 Cyc/Mn AC-23 2.5 Cyc/Mn AC-3 8.333 cyc/mn AC-15
Short-circuit current	10000 A
Short-circuit protection	16 A cartridge fuse, type gG
[Uimp] rated impulse withstand voltage	4 kV in isolating function 6 kV conforming to IEC 947-1
Contact operation	Slow-break
Positive opening	With
Electrical connection	Captive screw clamp terminals flexible, clamping capacity: 2 x 1.5 mm ² Captive screw clamp terminals solid, clamping capacity: 1 x 2.5 mm ²
Mechanical durability	1000000 cycles
CAD overall width	45 mm
CAD overall height	50 mm
CAD overall depth	69 mm
Net weight	0.19 kg

Environment

Standards	IEC 60947-3 for power circuit IEC 60947-5-1 for control circuit CENELEC EN 50013
Product certifications	CSA 240 V 3 hp 3 phases 2 pole(s)[RETURN]UL 240 V 0.33 hp 1 phase 2 pole(s) [RETURN]CSA 240 V 1 hp 1 phase[RETURN]UL 240 V 1 hp 3 phases
Protective treatment	TC
Ambient air temperature for operation	-25...55 °C
Ambient air temperature for storage	-40...70 °C
Shock resistance	30 gn conforming to IEC 68-2-27
Vibration resistance	5 gn conforming to IEC 68-2-6 (f = 10...150 Hz)
Electrical shock protection class	Class II conforming to IEC 536 Class II

Packing Units

Unit Type of Package 1	PCE
Number of Units in Package 1	1
Package 1 Height	6.500 cm
Package 1 Width	6.500 cm
Package 1 Length	16.500 cm
Package 1 Weight	202.000 g
Unit Type of Package 2	S01
Number of Units in Package 2	8
Package 2 Height	15.000 cm
Package 2 Width	15.000 cm
Package 2 Length	40.000 cm
Package 2 Weight	1.771 kg
Unit Type of Package 3	P06
Number of Units in Package 3	256
Package 3 Height	75.000 cm
Package 3 Width	80.000 cm
Package 3 Length	60.000 cm
Package 3 Weight	64.672 kg

Offer Sustainability

Sustainable offer status	Green Premium product
REACH Regulation	REACH Declaration
REACH free of SVHC	Yes
EU RoHS Directive	Pro-active compliance (Product out of EU RoHS legal scope) EU RoHS Declaration
Toxic heavy metal free	Yes
Mercury free	Yes
China RoHS Regulation	China RoHS Declaration
RoHS exemption information	Yes
Environmental Disclosure	Product Environmental Profile
Circularity Profile	No need of specific recycling operations
WEEE	The product must be disposed on European Union markets following specific waste collection and never end up in rubbish bins

Contractual warranty

Warranty	18 months
----------	-----------

Operating Head and Body with Plastic Base

Front Mounting by $\varnothing 22$ mm/0.87 in. Hole

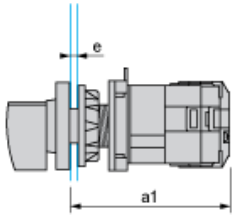

a1 90.5 mm/3.53 in.

e support panel thickness 1 mm to 6 mm./0.039 in. to 0.24 in.

Link Positions (Factory Mounted)

Diagram for 1 to 4-pole Switches

Select the number of poles according to the product characteristics.

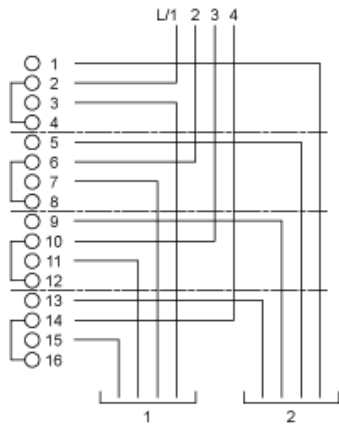

Marking

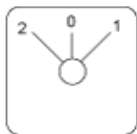

Angular Position of Switch

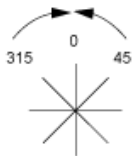

Switching Program

Diagram for 1 to 4-pole Switches

Select the number of poles according to the product characteristics.

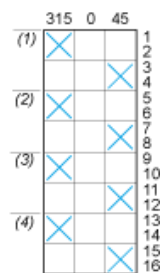



- (1) 1-pole
- (2) 2-pole
- (3) 3-pole
- (4) 4-pole

Convention Used for Switching Program Representation

 Contact closed

 Contact closed in 2 positions and maintained between the 2 positions

 Sealed assembly for auto-maintain control

 Overlapping contacts

 Spring return position: for a switching angle of 90°, spring return is over 30° after the last position (for a maximum of 3 simultaneous contacts).

Example:

